

PLF20-D6C-T1

Features

- ◆ Data rate: uplink 10.3125/1.25Gbps, downlink 10.3125/1.25Gbps application, support 10.3125/10.3125Gbps symmetric 10GEPON ONU, 10.3125/1.25Gbps asymmetric 10GEPON ONU and 1.25/1.25Gbps EPON ONU
- ◆ 1577nm continuous-mode EML DFB laser /1490nm continuous-mode DFB laser transmitter and 1270nm and 1310nm burst-mode APD-TIA receiver
- ◆ 10 Gigabit Small Form Factor Pluggable package with SC/UPC Connector
- ◆ 0~+70°C Operating Temperature, -40~+85°C Storage Temperature
- ◆ +3.3V power supply
- ◆ Digital diagnostic monitoring interface
- ◆ Digital burst RSSI function to monitor the input optical power level
- ◆ Transmitter internally AC coupled, differential lines should be terminated at the user SERDES
- ◆ LVTTTL transmitter disable control
- ◆ Very low EMI and excellent ESD protection

Applications

- ◆ SFP+ Asymmetric 10GEPON PRX30 OLT
- ◆ SFP+ Symmetric 10GEPON PR30 OLT
- ◆ SFP+ EPON PX20+ OLT

Standards

- ◆ Complies with SFP+ Multi-Source Agreement (MSA) SFF-8431
- ◆ Compliant with IEEE802.3av PRX30/PR30 and IEEE802.3ah PX20 specifications
- ◆ Class laser safety standard IEC I -60825 compliant
- ◆ Compatible with FCC Part 15 Class B /EN55022 Class B (CISPR 22B)/ VCCI Class B
- ◆ Complies with FDA 21 CFR 1040.10 and 1040.11 except for deviations pursuant to Laser Notice No. 50, dated June 24, 2007
- ◆ RoHS compliance

Description

The PLF20-D6C-T1 is a combination of 10G EPON OLT and 1G EPON OLT optical transceivers in an SFP+ housing. The 10G bidirectional link is configured with 1270nm/1577nm optics and the 1G link is configured with 1310nm/1490nm optics. The 1270nm and 1310nm optical burst mode receivers incorporate APD/TIA optics for maximum sensitivity. The 10G transmitter incorporates a 1577nm EML DFB laser assembly and the 1G transmitter incorporates a 1490nm DFB laser assembly. The transmitters can be controlled by the LVTTTL Tx_DISABLE function, the transmitters incorporate the LVTTTL Tx_Fault output and the receivers incorporate the LVTTTL Rx_LOS output.

Specification

Absolute Maximum Ratings				
Parameter	Symbol	Min	Max	Unit
Storage Ambient Temperature	T _{STG}	-40	+85	°C
Storage Humidity	H _S	0	95	%
Operating Humidity	H _O	0	85	%
Power Supply Voltage	V _{CC}	0	+3.6	V

Recommended Operating Conditions					
Parameter	Symbol	Min	Typical	Max	Unit
Operating Case Temperature	T _C	0		+70	°C
Power Supply Voltage	V _{CC}	3.135	3.3	3.465	V
Supply Current	I _{CC}			1200	mA
Power Consumption	P _W			4	W
Data Rate					Gbps
Fiber Length 9 um core SMF			20		km

Electrical Characteristics						
Parameter	Symbol	Min	Typical	Max	Unit	Notes
10G Transmitter Differential Input Voltage		120		800	mV	CML, AC Coupled
1G Transmitter Differential Input Voltage		120		800	mV	
Input Differential Impedance	Z _{in}	90	100	110	Ω	

10G Receiver Differential Output Voltage		400		800	mV	CML, DC Coupled
1G Receiver Differential Output Voltage		400		800	mV	
Output Differential Impedance	Z _{in}	90	100	110	Ω	
Transmit Fault Alarm Voltage	V _{OH}	2.4		V _{CC}	V	LVTTL
	V _{OL}	0		0.4	V	LVTTL
Transmit Disable Voltage	V _{OH}	2		V _{CC}	V	LVTTL
	V _{OL}	0		0.8	V	LVTTL
Loss Of Signal Voltage	V _{OH}	2.4		V _{CC}	V	LVTTL
	V _{OL}	0		0.4	V	LVTTL
Transmit Disable Assert Time	T _{off}			100	us	
Receiver Settling Time				400	ns	
Loss Of Signal Assert Time	T _D			512	ns	
Loss Of Signal De-assert Time	T _A			512	ns	

10GEPON Optical transmitter Characteristics						
Parameter	Symbol	Min	Typical	Max	Unit	Notes
Launched Power (avg.)	P _{OUT}	2		5	dBm	
Operating Wavelength Range	λ _C	1575	1577	1580	nm	EML DFB
Spectral Width (-20dB)	Δλ			1	nm	
Side Mode Suppression Ratio	SMSR	30			dB	
Extinction Ratio	ER	6			dB	PRBS 2 ³¹ -1 @10.3125Gbit/s
Transmitter and Dispersion Penalty	TDP			1.5	dB	Transmit on 20km SMF
Optical Output Power after TX Disable	P _{DIS}			-39	dBm	
Output Eye Diagram	Compliant with IEEE802.3av eye masks when filtered					Figure 1
EPON Optical transmitter Characteristics						
Parameter	Symbol	Min	Typical	Max	Unit	Notes
Launched Power (avg.)	P _{OUT}	3		7	dBm	
Operating Wavelength Range	λ _C	1480	1490	1500	nm	DFB
Spectral Width (-20dB)	Δλ			1	nm	

Side Mode Suppression Ratio	SMSR	30			dB	
Extinction Ratio	ER	9			dB	PRBS 2 ⁷ -1 @1.25Gbit/s
Transmitter and Dispersion Penalty	TDP			2.3	dB	Transmit on 20km SMF
Optical Output Power after TX Disable	P _{DIS}			-39	dBm	
Output Eye Diagram	Compliant with IEEE802.3ah eye masks when filtered					Figure 2

10GEPON Optical Receiver Characteristics						
Parameter	Symbol	Min	Typical	Max	Unit	Notes
Wavelength Range	λ_C	1260	1270	1280	nm	
Receiver Sensitivity	P _{SEN}			-28.5	dBm	PRBS 2 ³¹ -1 @10.3125Gbps, transmitter is operating, BER $\leq 1 \times 10^{-3}$
Optical Power Input Overload	S _{AT}	-6			dBm	
RX_LOS Assert	Pa	-35			dBm	
RX_LOS De-assert	Pd			-29	dBm	
EPON Optical Receiver Characteristics						
Parameter	Symbol	Min	Typical	Max	Unit	Notes
Wavelength Range	λ_C	1260	1310	1360	nm	
Receiver Sensitivity	P _{SEN}			-31	dBm	PRBS 2 ⁷ -1 @10.3125Gbps, transmitter is operating, BER $\leq 1 \times 10^{-12}$
Optical Power Input Overload	S _{AT}	-6			dBm	
RX_LOS Assert	Pa	-40			dBm	
RX_LOS De-assert	Pd			-31	dBm	

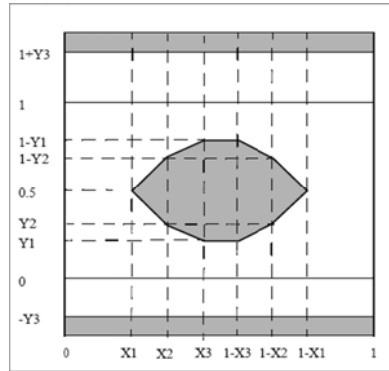

X1	X2	X3	Y1	Y2	Y3	Unit
0.25	0.40	0.45	0.25	0.28	0.40	UI

Figure 1 10GEPON Transmitter Eye Mask Definitions

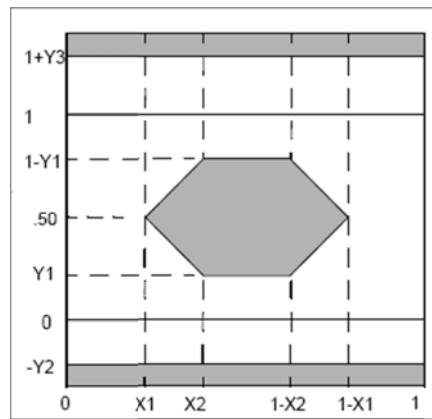

X1	X2	Y1	Y2	Y3	Unit
0.22	0.375	0.20	0.20	0.30	UI

Figure 2 GEAPON Transmitter Eye Mask Definitions

RSSI Characteristics						
Parameter	Symbol	Min.	Typ.	Max.	Unit	Notes
RSSI Trigger-Low		0		0.8	V	
RSSI Trigger-High		2.0		Vcc	V	
RSSI Trigger Delay	T _D	0	300		ns	
Uplink signal width	T _{ONT}		1500		ns	
RSSI Trigger width	T _W		500		ns	
I2C Access Prohibited Time	T _p			500	μs	

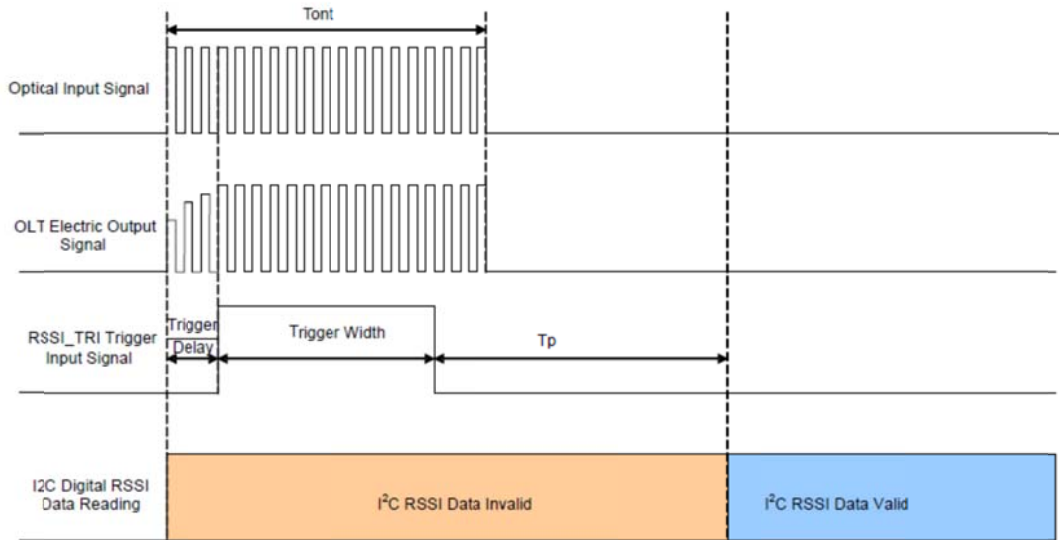

Figure 3 Timing Parameter Definitions in RSSI Trigger

Digital Diagnostic Monitoring Information

Parameter	Accuracy	Calibration	Note
Temperature	$\pm 3^{\circ}\text{C}$	Internal	
Voltage	$\pm 3\%$	Internal	
10G Bias Current	$\pm 10\%$	Internal	Quantization Unit 4uA
1G Bias Current	$\pm 10\%$	Internal	
10G TX Power	$\pm 2\text{dB}$	Internal	-33~7dBm (Quantization Unit 0.2 μW)
1G TX Power	$\pm 2\text{dB}$	Internal	
RX Power	$\pm 2\text{dB}$	External	-33to 7dBm(Quantization Unit 0.1 μW)

Note: The digital diagnostic monitoring interface defines 256-byte memory map in EEPROM, which makes use of the 8 bit address 1010001X(A2h). Please refer to the SFF-8472 for the detail information.

Pin definition

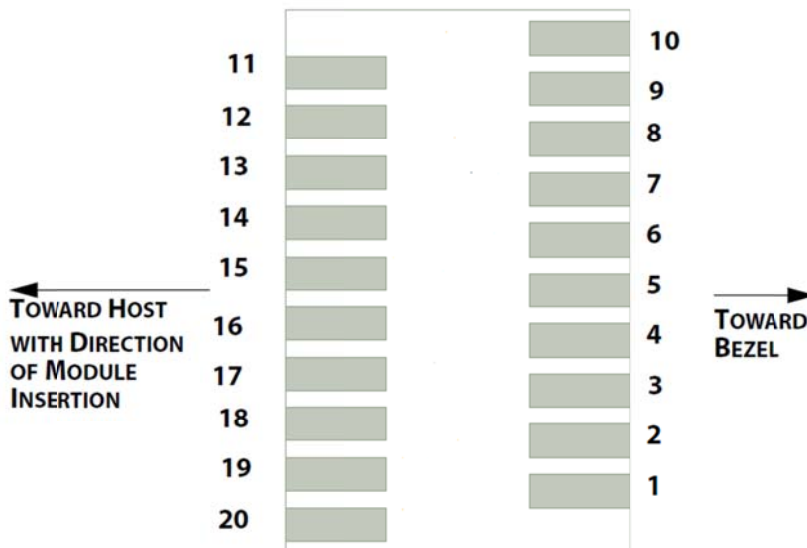

Figure 4 SFP+ Pad assignment Top View

Pin No	Symbol	Name/Description	Power Seq.	Note
1	EPON_TD+	1.25G Transmit Data In	3rd	CML logic input, AC coupled
2	EPON_TD-	1.25G Transmit Data In	3rd	CML logic input, AC coupled
3	GND	Module Ground	1st	
4	SDA	2-Wire Serial Interface Data Line (Same as MOD-DEF2 in INF-8074i)	3rd	SDA&SCL (IIC) are needed pull up 4.7k~10k Ohm resistors on host board.
5	SCL	2-Wire Serial Interface Data Line (Same as MOD-DEF2 in INF-8074i)	3rd	
6	EPON_RD-	1.25G Receiver Data Out	3rd	CML logic output, DC coupled
7	NC/RX_RateSel	NC or RX rate selection	3rd	High: Receiver data 10.3125Gbps; Low: Receiver data 1.25Gbps.
8	LOS	Receiver Loss of Signal indication	3rd	The host with a 4.7k~10k Ohm resistor High: loss of signal Low: signal detected
9	Trig/Txdis	RSSI/TXdisable Multiplexing Pin, Through Alternative Register Setting	3rd	The default state of Txdis with Internally 4.7k-10kΩ pull-up : High: transmitter disable; Low: transmitter enable .
10	EPON_RD+	1.25G Receiver Data Out	3rd	CML logic output, DC coupled

11	GND	Module Ground	1st	
12	10GEPON_RD-	10.3125G Receiver Data Out	3rd	CML logic output, DC coupled
13	10GEPON_RD+	10.3125G Receiver Data Out	3rd	CML logic output, DC coupled
14	TX-Fault	Transmitter Fault, Low: normal; High: abnormal	3rd	Pulled up a 4.7k~10k Ohm resistor on the host board
15	VCC3_RX	Module Receiver 3.3 V Supply	2nd	
16	VCC3_TX	Module Transmitter 3.3 V Supply	2nd	
17	NC		3rd	
18	10GEPON_TD+	10.3125G Transmit Data In	3rd	CML logic input, AC coupled
19	10GEPON_TD-	10.3125G Transmit Data In	3rd	CML logic input, AC coupled
20	GND	Module Ground	1st	

Typical application Circuit

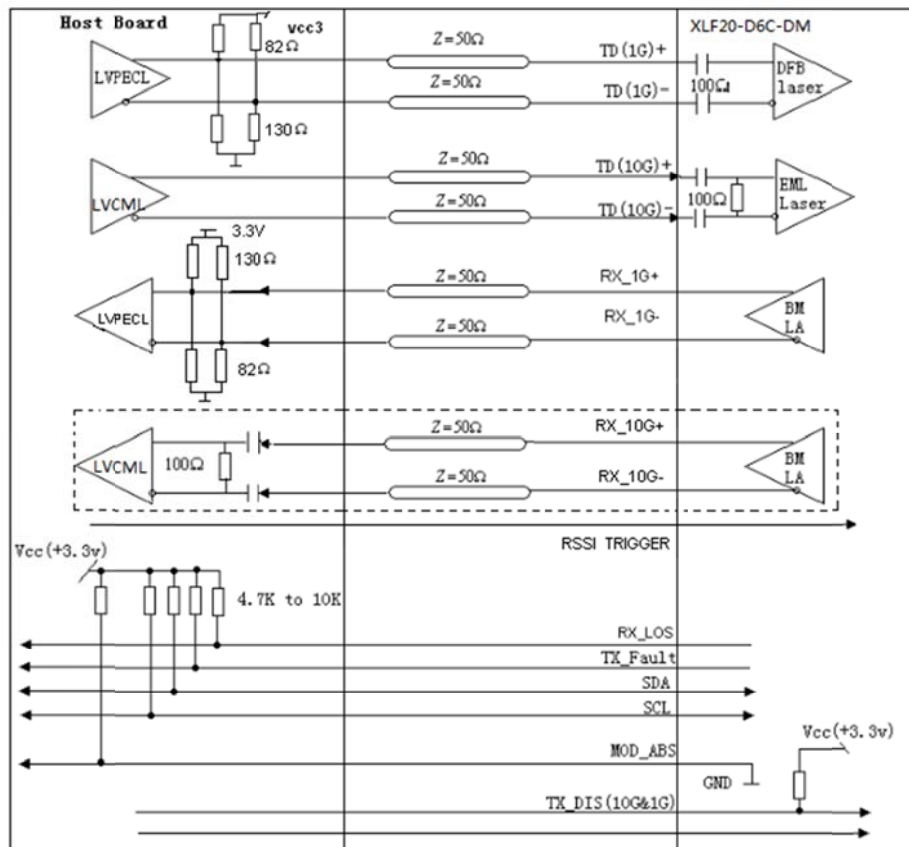

Figure 5 Typical Interface Circuit

EEPROM Memory Map

Memory map for SFP+ Symmetric 10GEPON OLT is illustrated in Figure 6. A0h(1010000X) and B0h(1011000X) are the Serial ID addresses for 10G EPON and EPON OLT, respectively. A2h(1010001X) and B2h(1011001X) are the Digital Diagnostic addresses for 10G EPON and EPON OLT, respectively.

Contents of Serial ID of 10G EPON and EPON OLT are defined in 2-Wire Address A0h/B0h. Contents of Digital Diagnostics Memory of 10G EPON and EPON OLT are defined in 2-Wire Address A2h/B2h. Both of 10G EPON and EPON are compatible with SFF-8472.

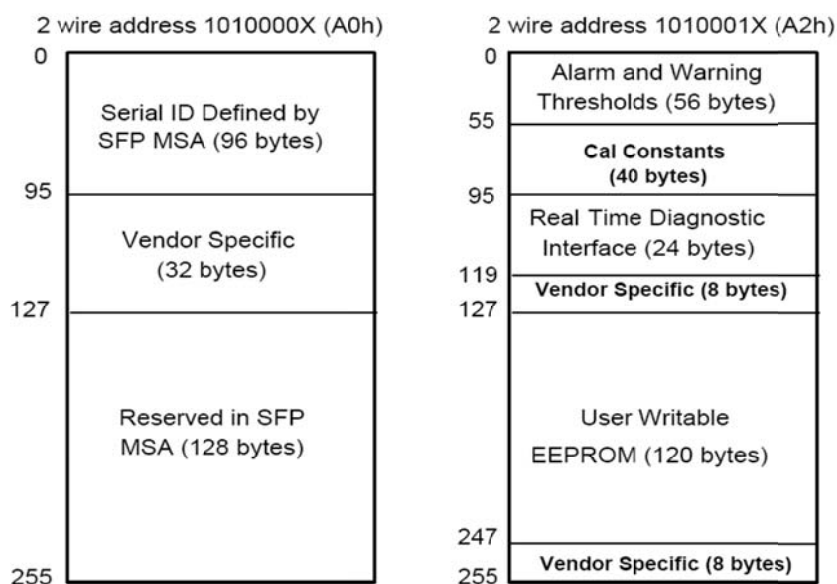

Figure 6 EEPROM Memory Map Specific Data Field Descriptions

EEPROM Serial ID Memory Contents

The optical transceiver contains an EEPROM. It provides access to sophisticated identification information that describes the transceiver's capabilities, standard interfaces, manufacturer, and other information. When the serial protocol is activated, the host generates the serial clock signal (SCL, Mod Def 1). The positive edge clocks data into those segments of the EEPROM that are not writing protected within the SFP transceiver. The negative edge clocks data from the SFP transceiver. The serial data signal (SDA, Mod Def 2) is bi-directional for serial data transfer. The host uses SDA in conjunction with SCL to mark the start and end of serial protocol activation. The memories are organized as a series of 8-bit data words that can be addressed individually or sequentially.

The Module provides diagnostic information about the present operating conditions. The transceiver generates this diagnostic data by digitization of internal analog signals. Calibration and alarm/warning threshold data is written during device manufacture. Received power monitoring, transmitted power monitoring, bias current monitoring, supply voltage monitoring and temperature monitoring all are

implemented. The diagnostic data are raw A/D values and must be converted to real world units using calibration constants stored in EEPROM locations 56 – 95 at wire serial bus address A2h. The digital diagnostic memory map specific data fields define as following.

10GEPON EEPROM Serial ID Memory Contents (2-Wire Address A0h)

Address	Name of field	Hex	Description
BASE ID Fields			
00	Identifier	03	SFP Plus transceiver
01	Ext. Identifier	04	Serial ID module supported for SFP Plus
02	Connector	01	SC
03-05	Transceiver Codes	00 00 00	Not defined
06	Transceiver Codes	00	Not defined
07-10	Transceiver Codes	00 00 00	Not defined
11	Encoding	06	Encoding codes
12	BR, Nominal	64	
13	Rate Identifier	00	Not defined
14	Length(9um)-km	14	
15	Length(9um)-m	C8	
16	Length(50um)	00	Transceiver transmit distance
17	Length(62.5um)	00	
18	Length(cable)	00	Not support cable
19	Length(OM3)	00	Not support OM3
20-35	Vendor Name	4D 45 4E 54 45 43 48 4F 50 54 4F 20 20 20 20 20	"MENTECHOPTO"(ASCII character)
36	Reserved	00	Not defined
37-39	Vendor OUI	00 00 00	Not defined
40-55	Vendor P/N	50 4C 46 32 30 2D 44 36 43 2D 54 1F	"PLF20-D6C-T1"(ASCII character)
56-59	Vendor P/N Rev.	41 30 20 20	"A0"(ASCII character)
60-61	Laser Wavelength	06 29	1577nm
62	Reserved	00	Not defined
63	CC_BASE	xx	Check sum of bytes 0-62
Extended ID Fields			
64-65	Options	00 1A	TX_Disable、TX_Fault and RX_SD are implemented

66	BR, max	00	Upper bit rate margin,20%
67	BR, min	00	Lower bit rate margin,20%
68-83	Vendor SN	xx.....xx	Vendor Serial Number in ASCII character
84-91	Date Code	Data Code	Vendor Date Code in ASCII character
92	Diagnostic Monitoring Type	68	Digital Diagnostic monitoring implemented "External calibrated" is implemented, RX measurement type is "Average Power"
93	Enhanced options	E0	Optional Alarm/warning flags, soft Tx_Disable control and monitoring, soft Tx_Fault monitoring are implemented
94	SFF-8472 compliant	08	SFF-8472 compliant with revision 12.0
95	CC-EXT	xx	Check sum of bytes 64-94
Vendor Specific ID Field			
96-127	Vendor Specific	00	Vendor specific EEPROM
128-255	Reserved	00	Reserved for future use

EPON EEPROM Serial ID Memory Contents (2-Wire Address B0h)

Address	Name of field	Hex	Description
BASE ID Fields			
00	Identifier	03	SFP Plus transceiver
01	Ext. Identifier	04	Serial ID module supported for SFP Plus
02	Connector	01	SC
03-05	Transceiver Codes	00 00 00	Not defined
06	Transceiver Codes	00	Not defined
07-10	Transceiver Codes	00 00 00	Not defined
11	Encoding	01	Encoding codes
12	BR, Nominal	0A	
13	Rate Identifier	0	Not defined
14	Length(9um)-km	14	
15	Length(9um)-m	C8	
16	Length(50um)	00	Transceiver transmit distance
17	Length(62.5um)	00	
18	Length(cable)	00	Not support cable
19	Length(OM3)	00	Not support OM3

20-35	Vendor Name	4D 45 4E 54 45 43 48 4F 50 54 4F 20 20 20 20 20	"MENTECHOPTO"(ASCII character)
36	Reserved	00	Not defined
37-39	Vendor OUI	00 00 00	Not defined
40-55	Vendor P/N	50 4C 46 32 30 2D 44 36 43 2D 54 1F	"PLF20-D6C-T1"(ASCII character)
56-59	Vendor P/N Rev.	41 30 20 20	"A0"(ASCII character)
60-61	Laser Wavelength	05 D2	1490nm
62	Reserved	00	Not defined
63	CC_BASE	xx	Check sum of bytes 0-62
Extended ID Fields			
64-65	Options	00 1A	TX_Disable、TX_Faultand RX_SD are implemented
66	BR, max	00	Upper bit rate margin,20%
67	BR, min	00	Lower bit rate margin,20%
68-83	Vendor SN	xx.....xx	Vendor Serial Number in ASCII character
84-91	Date Code	Data Code	Vendor Date Code in ASCII character
92	Diagnostic Monitoring Type	68	Digital Diagnostic monitoring implemented "External calibrated" is implemented, RX measurement type is "Average Power"
93	Enhanced options	E0	Optional Alarm/warning flags, soft Tx_Disable control and monitoring, soft Tx_Fault monitoring are implemented
94	SFF-8472 compliant	08	SFF-8472 compliant with revision 12.0
95	CC-EXT	xx	Check sum of bytes 64-94
Vendor Specific ID Field			
96-127	Vendor Specific	00	Vendor specific EEPROM
128-255	Reserved	00	Reserved for future use

Digital Diagnostic Monitoring Interface:

10GEPON Alarm and Warning Thresholds (2-Wire Address A2h)

Address	#Bytes	Name	Real Value	Unit	Hex
00-01	2	Temp High Alarm	85	°C	
02-03	2	Temp Low Alarm	-35	°C	
04-05	2	Temp High Warning	80	°C	
06-07	2	Temp Low Warning	-30	°C	
08-09	2	Voltage High Alarm	3.6	V	
10-11	2	Voltage Low Alarm	3	V	
12-13	2	Voltage High Warning	3.5	V	
14-15	2	Voltage Low Warning	3.1	V	
16-17	2	Bias High Alarm	125	mA	
18-19	2	Bias Low Alarm	5	mA	
20-21	2	Bias High Warning	110	mA	
22-23	2	Bias Low Warning	10	mA	
24-25	2	TX Power High Alarm	7	dBm	
26-27	2	TX Power Low Alarm	0	dBm	
28-29	2	TX Power High Warning	5	dBm	
30-31	2	TX Power Low Warning	2	dBm	
32-33	2	RX Power High Alarm	-4	dBm	
34-35	2	RX Power Low Alarm	-30.5	dBm	
36-37	2	RX Power High Warning	-6	dBm	
38-39	2	RX Power Low Warning	-28.5	dBm	
40-41	2	TOSA Temp High Alarm	60	°C	
42-43	2	TOSA Temp Low Alarm	30	°C	
44-45	2	TOSA Temp High warning	50	°C	
46-47	2	TOSA Temp low warning	40	°C	
48-55	8	Reserved	Reserved		

EPON Alarm and Warning Thresholds (2-Wire Address B2h)

Address	#Bytes	Name	Real Value	Unit	Hex
00-01	2	Temp High Alarm	85	°C	
02-03	2	Temp Low Alarm	-35	°C	
04-05	2	Temp High Warning	80	°C	

06-07	2	Temp Low Warning	-30	°C	
08-09	2	Voltage High Alarm	3.6	V	
10-11	2	Voltage Low Alarm	3	V	
12-13	2	Voltage High Warning	3.5	V	
14-15	2	Voltage Low Warning	3.1	V	
16-17	2	Bias High Alarm	80	mA	
18-19	2	Bias Low Alarm	1	mA	
20-21	2	Bias High Warning	65	mA	
22-23	2	Bias Low Warning	2	mA	
24-25	2	TX Power High Alarm	9	dBm	
26-27	2	TX Power Low Alarm	1	dBm	
28-29	2	TX Power High Warning	7	dBm	
30-31	2	TX Power Low Warning	3	dBm	
32-33	2	RX Power High Alarm	-4	dBm	
34-35	2	RX Power Low Alarm	-33	dBm	
36-37	2	RX Power High Warning	-6	dBm	
38-39	2	RX Power Low Warning	-31	dBm	
40-55	16	Reserved	Reserved		

EEPROM A2/B2 RSSI selection

Address	Bit	Name	Description
118	7	RSSI Select	Writing "0" for 10GEPON RSSI Monitor; Writing "1" for EPON RSSI Monitor. Default power up value is "0".
118	6	RSSI/TX_disable	When set "0", PIN9 input as TX_Disable input; When set "1", PIN9 as RSSI input. Default power up value is "0".

Package Outline

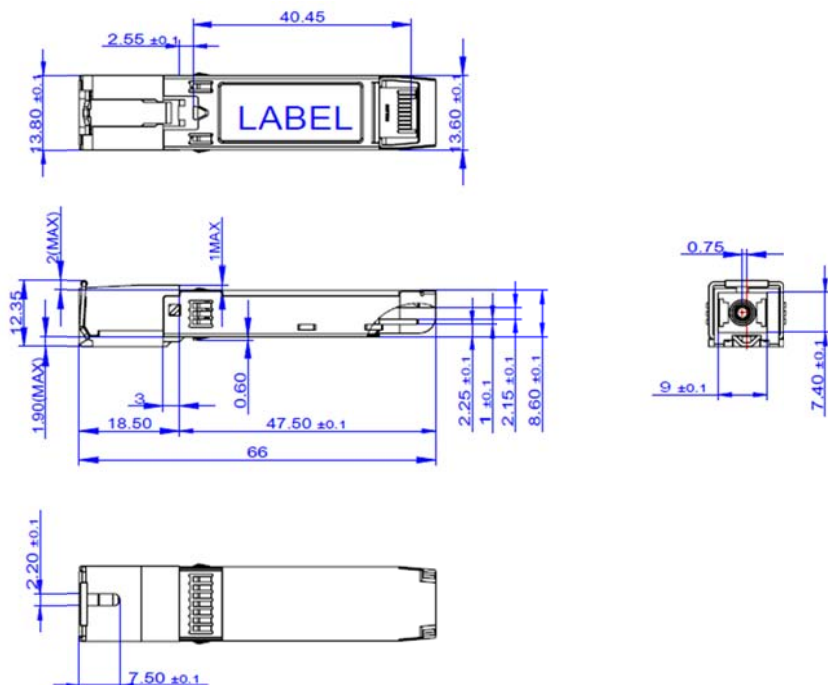

Figure 7 Package Outline

Ordering information

PART NO.	Specifications								
	Package	Rate (Gbps)	Tx (nm)	Po (dBm)	Rx (nm)	Sen (dBm)	Temp (°C)	Reach (km)	DDM
PLF20-D6 C-T1	SFP+	10.3125 TX/ 10.3125 RX	1577	2~5	1270	<-28.5	0~+70	20	Y
		1.25 TX/ 1.25 RX	1490	3~7	1310	<-31	0~+70	20	Y